

User Manual

ER-101 Indexed Quad Sequencer

with

Firmware v2.09

Content that is specific to this firmware version is highlighted in red.
(last updated: August 20, 2018)

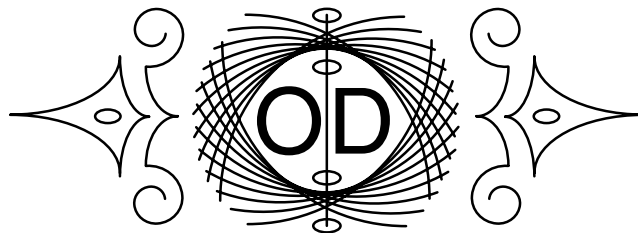

Orthogonal Devices © 2018

If you find any typos, errors, or poor wording in this manual please let me know.

<http://www.orthogonaldevices.com/contact>

Contents

What does it do?	3
Quick Start	4
The Front Panel	5
Anatomy of a Sequence	9
Sequence Navigation	10
Sequence Editing	11
The Modes	13
Snapshots	14
Track Options	15
Swinging and Shuffling	16
Voltage Tables	17
Loop Points	21
Smoothing Transitions	23
Ratcheting (aka note repeat)	24
Math Operations	25
Outputting Triggers	28
Clock Division & Multiplication	29
Tips & Tricks	31
Common Pitfalls	33
Technical Matters	34

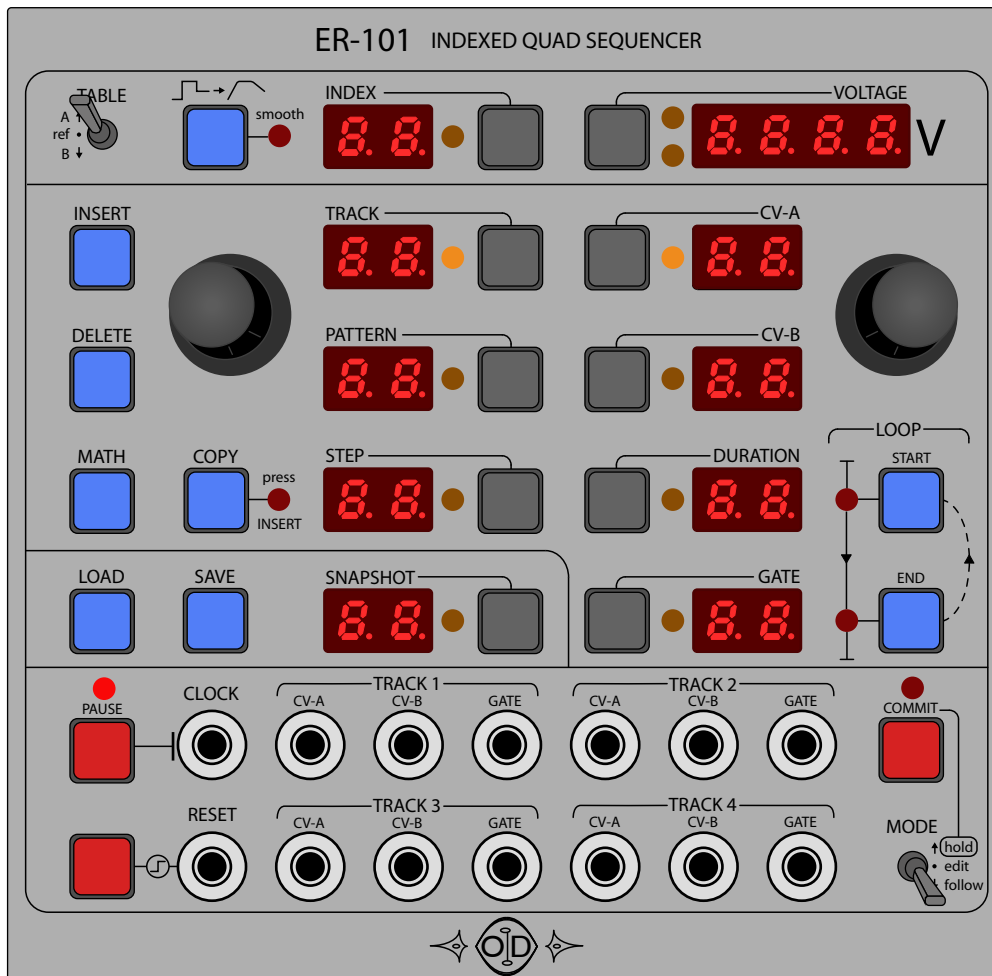

What does it do?

“Research has shown that using the ER-101 may not make your music sound better but it **Will** make you smarter!” -anonymous

The ER-101 Indexed Quad Sequencer is an externally clocked and resettable 4-track sequencer for the Eurorack modular format. Each track consists of 2 analog control voltage outputs referred to as CV-A and CV-B, and, one digital output referred to as GATE. The ER-101’s purpose is to provide the musician with a tool for creating and manipulating clock-synced control voltage contours of great length and complexity. Probably the most traditional (but still very relevant) patch for a track’s output is:

Pitch Control:	CV-A to the 1V/oct input of a VCO (voltage-controlled oscillator)
Velocity Control:	CV-B to the level input of an EG (envelope generator)
Note On/Off:	GATE to the gate input of the same EG

Patched this way, the ER-101 gives you the ability to create almost any 4-part harmony in any scale with arbitrary dynamics and rhythm (up to the clock period). However, as many modular enthusiasts will already know, this is only like dipping your toes in the tops of Jupiter’s clouds, because the full brutal and subtle strength of your modular lies within a storm of complex, and sometimes chaotic, cross-modulations. The ER-101 can be a tool that enables you to inject just the right of amount of structure, repeatability, and control into your stormy creations. On the other hand, the ER-101’s randomization and jittering operations, its penchant for complex phasing in time across tracks, and its ability to store thousands of steps for seemingly infinite variation, can be used to make just a few VCOs and VCFs sound like a huge workstation synthesizer.

Quick Start

This is a very simple but detailed recipe just to get the ball rolling and to make sure everything is working as it should. However, keep in mind that there are many things about the ER-101 that may not be obvious. So please make sure to eventually look over the rest of the manual. (In the following, whenever I write “focus X”, what I mean is that you should press the button next to the X display so that its orange LED lights up. More details on navigating the ER-101’s interface can be found in the section called Front Panel.)

1. Clock the ER-101 with a 4ppqn pulse or similar. So for a 120BPM tempo and assuming 4/4 time, the ER-101 should receive a clock that pulses at $4ppqn \times 120BPM = 480BPM$. If you want to run the ER-101 from a slower clock but keep the same time signature then please see the section entitled Clock Multiplication.
2. Make sure the TABLE switch is set to A and the MODE switch is set to ‘edit’.
3. Patch Track 1 CV-A to VCO’s 1V/oct input and Track 1 GATE to a VCA that is gating the output of the VCO. Listen to the output of the VCO.
4. LOAD a blank snapshot by focusing the SNAPSHOT display and using the left encoder to select the snapshot called ‘--’. Finally, press the LOAD button twice.
5. Focus the STEP display and INSERT a step, focus the DURATION display and set the DURATION to 4 (right encoder), and focus the GATE display and set the GATE to 2 (again, right encoder). The default CV-A value should be 12 (1.C.00 or 1.000V) because the default voltage table is 12ET (12-tone equal tempered).
6. If the PAUSE LED is lit, then press the PAUSE button to unpause the ER-101.
7. You should now hear your VCA opening on every beat and then closing half-way through each step (because each beat is 4 clock pulses, your steps are 4 pulses in duration, and the gate is high for 2 pulses).
8. Press the INSERT button again (while the STEP display is focused) and a duplicated step will be appended to your track, resulting in a two step sequence. (Note: it is possible to insert material before or after the current cursor position or even to split a step, see the section entitled Sequence Editing for more details.)
9. Focus the CV-A display and change the value of CV-A to 24 which corresponds the 24th entry in the current voltage table. In our case, that should be 12ET and thus corresponds to 2.C.00 (or 2.000V). You should be hearing two notes an octave apart playing on the beat. For more information on voltage tables please refer to the section called Voltage Tables.
10. Focus the DURATION and change it to 8. Now the higher note should be playing twice as long as the lower note.
11. Focus the GATE and slowly decrease it to zero. Note how the focused note becomes more and more staccato until when GATE=0 it doesn’t play at all (i.e. a rest). Try making the GATE longer until it equals the DURATION (i.e. legato).
12. Move the MODE switch to the FOLLOW mode and observe that the two steps are alternating. Try turning the LEFT knob to scrub the play position. Read the section entitled The Modes to learn about the difference between edit cursors and play cursors.

At this point, I hope you can see & hear the relationship between the external clock and the DURATION/GATE parameters, and, how the voltages are being indexed from the voltage table to select the pitch of a VCO. The rabbit hole goes much deeper however, so I invite you to continue your journey!

The Front Panel

Here we will summarize, one-by-one, the purpose of each interface element on the ER-101's front panel. A section name in bold indicates a link to a more detailed description of the element in question.

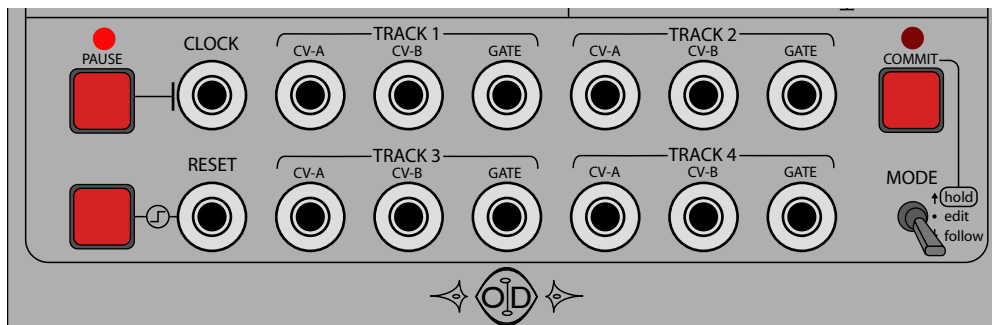

CLOCK input

The signal patched into the CLOCK input controls the timing of all four tracks simultaneously. While the ER-101 is not paused, a rising edge on the CLOCK input will advance the play cursor on all tracks. The threshold voltage for a valid trigger is 2.5V. This clock may be multiplied and/or divided, internally.

PAUSE button

Next to the CLOCK input is a PAUSE button which is used to temporarily disable the clock signal presented at the input. The CLOCK input is inhibited when the pause LED is lit.

RESET input and button

A rising edge on the RESET input will rewind all four tracks simultaneously to the 1st step of the 1st pattern regardless of any loop points. The RESET button is the same as manually presenting a rising edge at the RESET input. You can also quantize (in time) a reset by holding the TRACK, PATTERN, or STEP focus button while pressing the RESET button. This will cause the actual RESET to coincide with the next time the current TRACK, PATTERN, or STEP ends, respectively. The threshold voltage for a valid trigger is 2.5V.

TRACK outputs | Anatomy of a Sequence

Each of the four tracks has its own CV-A, CV-B and GATE outputs. The two control voltage outputs (CV-A and CV-B) have a resolution of 14-bits and a range of 0-8.192V. You can specify voltages with a precision of 0.002V and an accuracy of $\pm 0.002V$. The GATE outputs are 0V when low and at least 9.0V when high. All outputs are updated at a rate of approximately 3kHz, or in other words, with a maximum latency of 0.333ms.

COMMIT button and MODE switch | The Modes

Together these control whether the user is manipulating the play cursor or the edit cursor, and, whether the user is operating on live material or a copy of the live material.

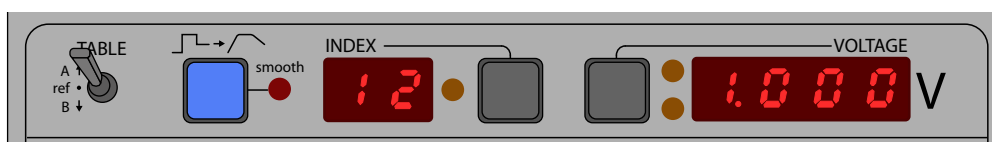

TABLE switch | Voltage Tables

This switch selects whether CV-A or CV-B voltages are being displayed to the right and also lets you browse the REFERENCE tables.

SMOOTH button | Smoothing Transitions

This button toggles smoothing of voltage transitions for either the entire track, a pattern, or a step depending on the current focus.

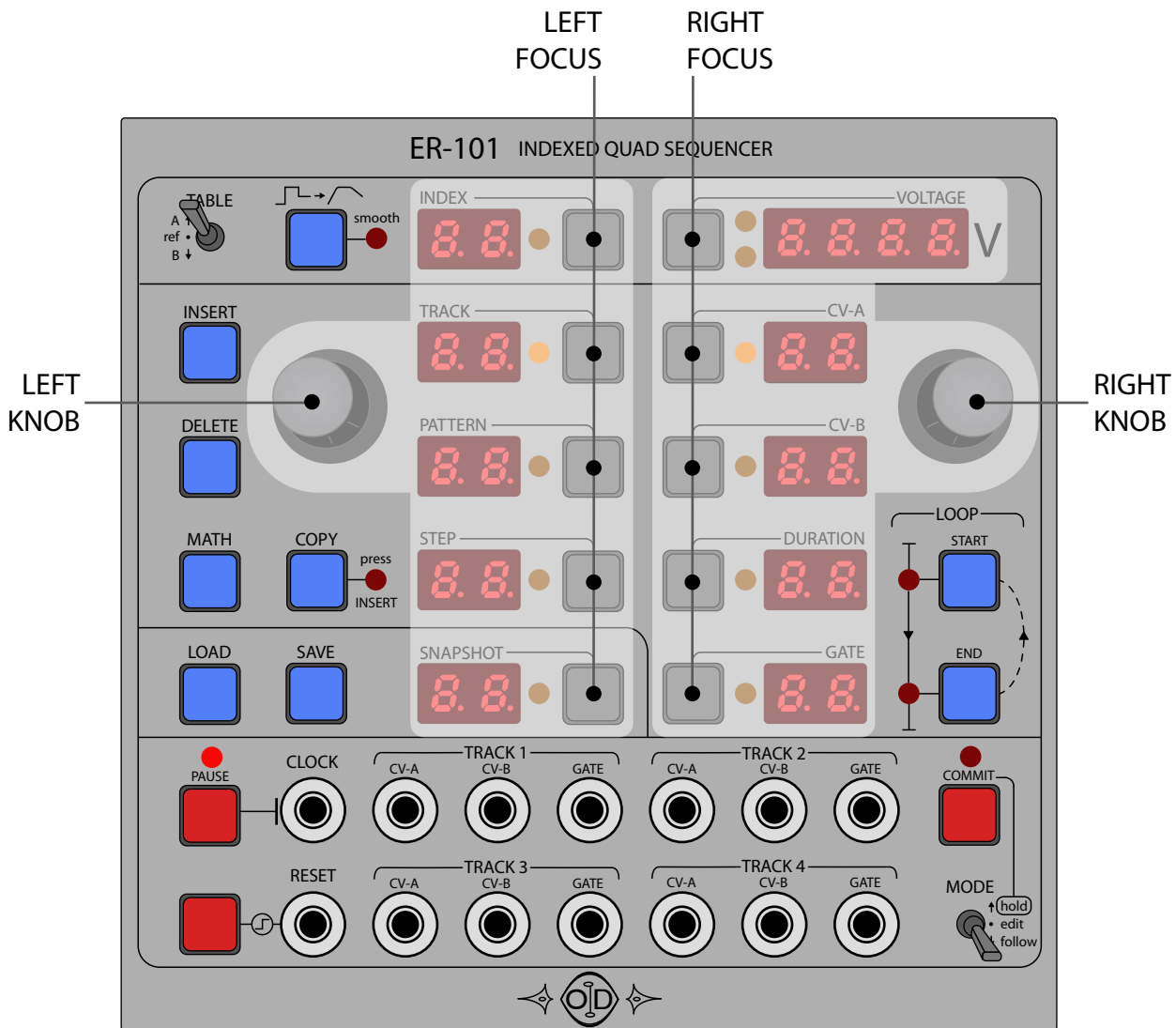

Figure 1

Encoders and Focus Buttons

The top portion of the ER-101's panel is roughly divided into two halves as shown in Figure 1. The left portion contains navigation elements such as INDEX, TRACK, PATTERN, STEP, and SNAPSHOT. The right portion contains parameters such as VOLTAGE, CV-A, CV-B, DURATION, and GATE. You select what you want to adjust by pressing the appropriate focus button and then adjusting the value with the knob for that half.

For example in Figure 2 we are navigating to a specific STEP and then selecting the CV-A parameter and adjusting it. Notice that the ER-101 is designed to be used efficiently with two hands. The essential idea to remember is that the numeric display that currently has your attention should be between your left and right hand. Particularly the bottom frame of Figure 2 shows how you can rapidly change the CV-A parameter for many steps in succession by having STEP and CV-A focused while keeping your hands on the left and right knobs.

Focus buttons are also used to indicate the focus of various operations such as:

- MATH: The focus determines what gets transformed, a step, a pattern or an entire track.
- COPY: The focus determines what gets copied to the clipboard.
- INSERT: The focus determines where contents get pasted.
- COMMIT: The focus determines quantization granularity of the commit.
- SMOOTH: The focus determines what gets smoothed.
- RESET: Holding a focus button while pressing RESET determines quantization.

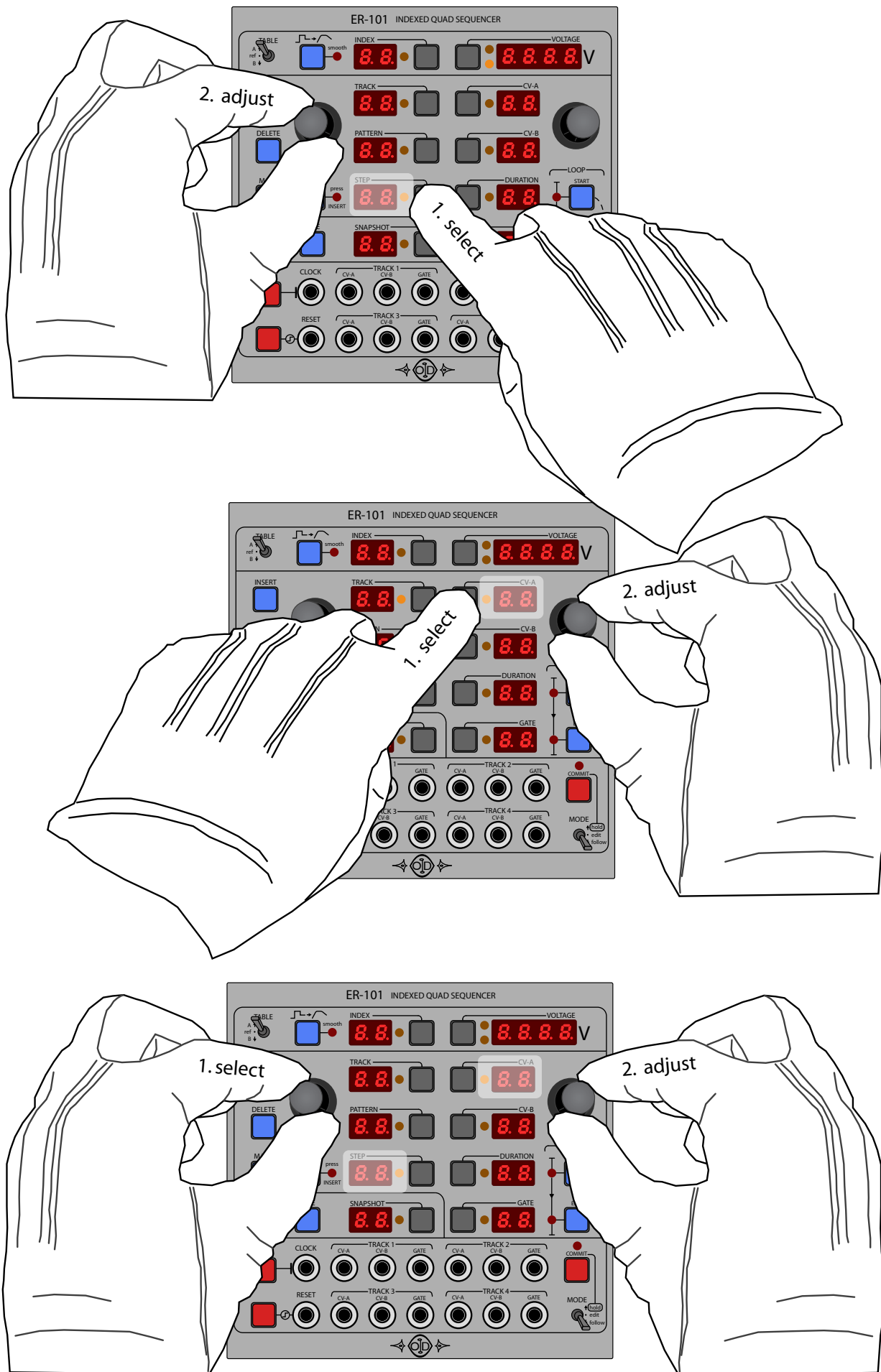
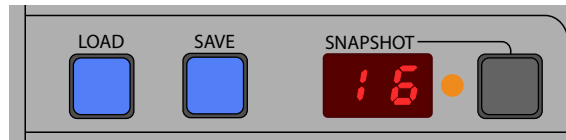
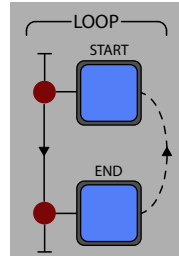

Figure 2



LOAD and SAVE buttons | Snapshots

These buttons recall and store snapshots to the location shown in the display. The available snapshots slots are numbered 1 through 16. There is also a blank snapshot displayed as '--' which is located before snapshot number 1. LOADING this blank snapshot, clears everything (except your saved snapshots).



LOOP START and END buttons | Loop Points

These buttons are used to adjust what subsection of the current sequence is looped. The LEDs light up when the current step is either the start or end of the loop. Each track has its own loop points.

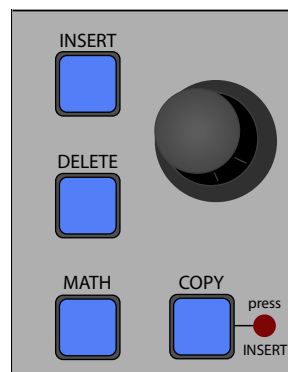

INSERT button | Sequence Editing

This button is used to insert new material into the currently focused track. Depending on the context, you can insert new steps, new patterns, or insert material from the clipboard. The default behavior is to insert after the current cursor but you can also insert before or even split the focused step or pattern into two halves.

DELETE button | Sequence Editing

This button is used to delete steps, patterns, or even clear an entire track. Use with caution. You cannot delete a snapshot with this button. You can only overwrite snapshots with the SAVE button.

COPY button | Sequence Editing

Use this button to copy the current step or pattern or track to the clipboard. You can also hold the button down and “drag” the cursor with the LEFT knob to select a range of steps or patterns that then get copied to the clipboard when you release the COPY button. The LED next to the COPY button will flash when the clipboard has content ready to be pasted.

MATH button | Math Operations

This button is a small doorway into a world of sequence transformation.

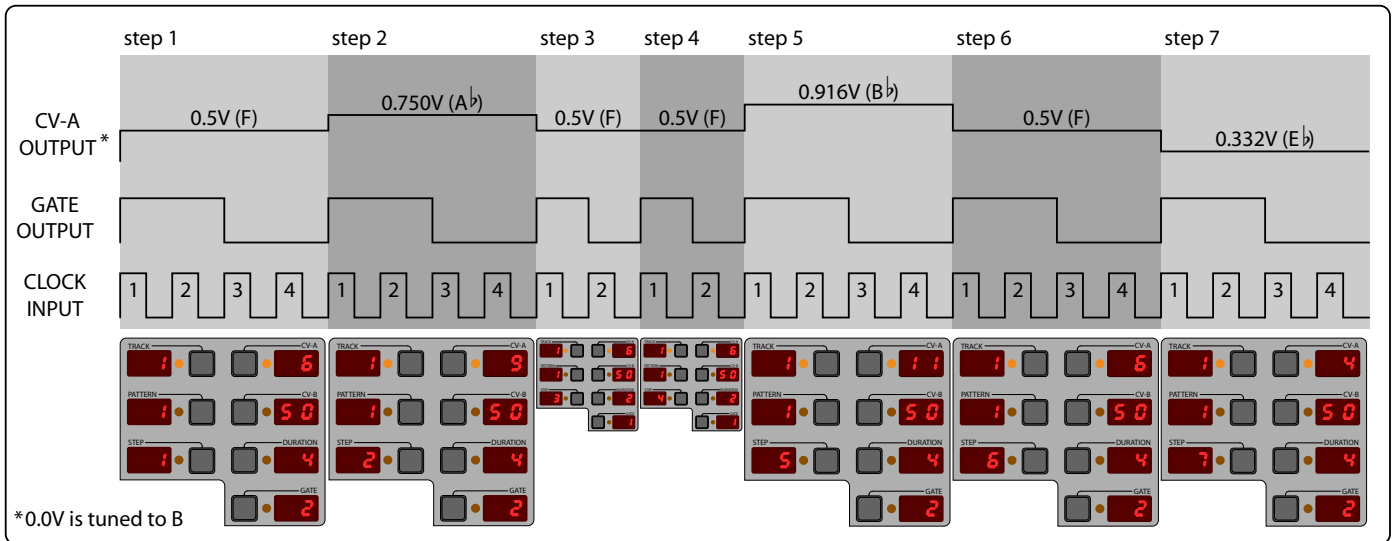

Figure 3: a short 7-step sequence using the builtin 12ET (chromatic) voltage table.

Anatomy of a Sequence

Each of the ER-101's four tracks can contain up to 100 patterns that play sequentially from beginning to end and then loop. Each pattern can contain up to 100 steps that play sequentially from beginning to end. However, the total number of steps for all four tracks cannot exceed 2000. Each step has a variable duration from 0-99 clock pulses and a variable gate duration from 0-99 clock pulses.

What is a step?

Each step has 4 basic parameters that range from 0-99:

CV-A:	index into the track's voltage table A
CV-B:	index into the track's voltage table B
DURATION:	length of the step in clock cycles
GATE:	length of the logic high portion of the gate in clock cycles

When a particular step is in focus (see Sequence Navigation) then you can edit any of these parameters with the following procedure:

To adjust a step parameter

1. Press and release the focus button for the desired parameter, if necessary.
2. Use the RIGHT knob to adjust the parameter to the desired value.

What is a pattern?

A pattern is nothing more than a sequence of steps. The purpose of patterns in the ER-101 is to divide a long sequence of steps into smaller and thus more manageable pieces. It is completely up to the user to decide how to divide a step sequence into patterns. When first starting with the ER-101 it helps to think of patterns as having the same role as measures in traditional music notation. Patterns help you navigate your song and let you think of your song in logical sections that might for example all have the same number of beats or they might be variations of a theme. Finally, certain user interface elements of the ER-101 operate on patterns such as navigation, copying, looping, math operations and so on.

A Note about pattern sequencing: Some users when they see the word PATTERN might immediately think of pattern sequencing. The ER-101 doesn't explicitly have any facilities for sequencing patterns. The patterns of a track play sequentially. However, you can achieve just about everything a pattern arranger can do and more by just "playing" the LOOP points like you would on a sample looper.

Sequence Navigation

Each of the ER-101's four tracks has an edit cursor and a play cursor which are completely independent. The play cursor determines what is actually being rendered to the CV and GATE outputs. The edit cursor provides another view that is separate from the play cursor, and thus allows you to navigate around a sequence and change things while playback continues. Read the section called *The Modes* for more details on how to use these cursors. For now, let's just concentrate on manipulating the edit cursor which means that the ER-101's MODE switch is in the EDIT position.

The basic procedure for navigating to any specific step within a track is

1. If necessary, focus the TRACK display (i.e. by pressing and releasing the TRACK button)
2. Select the TRACK with the LEFT knob.
3. Focus the STEP display.
4. Select the STEP with the LEFT knob.

As you scroll through the steps in a track, the PATTERN display will also update to reflect which pattern contains the current step. Once a track gets very long, it is quicker to navigate around the track by PATTERN. The procedure is similar:

1. Focus the TRACK display.
2. Select the TRACK with the LEFT knob.
3. Focus the PATTERN display.
4. Select the PATTERN with the LEFT knob.
5. Focus the STEP display.
6. Select the STEP with the LEFT knob.

However, there is one subtle difference when navigating by PATTERN. As you scroll forward through the patterns, notice that the STEP display will show the first and then the last step of the each pattern and vice versa when scrolling backwards. This gives you a quick way to jump to the beginning or end of a pattern. This convenience of navigating a long track quickly via patterns is one of the reasons why it is good to break a track up into patterns.

Tip: You can focus press PATTERN or TRACK to have the total number of pulses for all steps shown in the VOLTAGE display. Focus press means pressing the focus button when the display is already focused.

Sequence Editing

For the following we will assume that the ER-101 mode switch is set to EDIT or HOLD. These instructions can also apply to the case when the mode switch is set to FOLLOW but only when the ER-101 is PAUSED. Read the section called The Modes for more details about using the MODE switch.

Creating and editing a sequence relies on two basic operations: INSERT and DELETE. You can insert:

a step
or
a pattern
or
a sequence of steps
or
a sequence of patterns

as well as delete them. When the COPY indicator is not lit then the INSERT button will insert either a new step or a new empty pattern depending on whether the STEP or PATTERN display is focused.

To insert a new step (or pattern) after the current step (or pattern)

1. Focus the STEP (or PATTERN) display, if necessary.
2. Press and release the INSERT button.

To insert a new step (or pattern) before the current step (or pattern)

1. Focus the STEP (or PATTERN) display, if necessary.
2. Press and hold the INSERT button.
3. Turn the RIGHT knob counter-clockwise until the VOLTAGE display shows '*bEFr*'.
4. Release the INSERT button.

Insert after, insert before, or split: Notice that when the INSERT button is held the VOLTAGE display shows the word '*AFtr*' which means that the inserted step or pattern will go after the focused step or pattern. While still holding the INSERT button, if you turn the RIGHT knob counter-clockwise, the VOLTAGE display changes to '*SPLt*' which means that the new step or pattern is created by splitting the current step or pattern. Steps are split in half while preserving the total duration. Thus a step with DURATION=4 will split into two steps with DURATION=2, while a step with DURATION=5 will split into two steps, one of DURATION=3 and another with DURATION=2. Patterns are split at the cursor position. Turning the RIGHT knob further changes the VOLTAGE display to '*bEFr*', which is used to insert before the current focus. Insertion actually happens when you release the INSERT button.

The parameters of a newly inserted step are initialized in the following manner:

CV-A:	defaults to the index which yields the closest voltage to 1.0V in table A.
CV-B:	defaults to the index which yields the closest voltage to 1.0V in table B.
DURATION:	defaults to zero, so that initially this step is skipped.
GATE:	defaults to zero.

In general, the DELETE button will remove the focus step or pattern from the current track:

To delete the current step/pattern

1. Focus the STEP (or PATTERN) display, if necessary.
2. Press and release the DELETE button.

To clear the entire track

1. Focus the TRACK display, if necessary.
2. Press the DELETE button.
3. To confirm, press the DELETE button again.
4. To abort, press any other button.

The COPY button can be used to copy steps or patterns to the clipboard and then INSERT copies in other locations, even on other tracks:

To copy the current step/pattern to the clipboard

1. Focus the STEP (or PATTERN) display, if necessary.
2. Press the COPY button

At this point the COPY indicator will light up and depending on whether you copied a step or a pattern the STEP or PATTERN indicator will be flashing. To clear the clipboard, press the COPY button again.

To paste the step/pattern on the clipboard after the current step/pattern

1. Focus the STEP (or PATTERN) display, if necessary.
2. Press and release the INSERT button.

To paste the step/pattern on the clipboard before the current step/pattern

1. Focus the STEP (or PATTERN) display, if necessary.
2. Press and hold the INSERT button.
3. Turn the RIGHT knob counter-clockwise.
4. Release the INSERT button and repeat as many times as desired.
5. To clear the clipboard, press the COPY button again.

Notice that if you have a step copied to the clipboard (therefore the STEP indicator is flashing) but then press the INSERT button while the PATTERN display is focused, then a new pattern will be inserted. Similarly, if you have a pattern copied to the clipboard (therefore the PATTERN indicator is flashing) but then press the INSERT button while the STEP display is focused, then a new step will be inserted.

To copy one track onto another track

1. Focus the TRACK display, if necessary.
2. Select the track to copy with the LEFT knob and press the COPY button.
3. Select the destination track and press the INSERT button.
4. Repeat 3 as many times as desired.
5. To clear the clipboard, press the COPY button again.

You can also copy a range of steps or patterns to the clipboard by pressing and holding the COPY button while turning the LEFT knob.

To copy a range of steps/patterns to the clipboard

1. Focus the STEP (or PATTERN) display, if necessary.
2. Turn the LEFT knob to the step (or pattern) that marks the start of the range that you want to copy.
3. Press and hold the COPY button.
4. Turn the LEFT knob to the step (or pattern) that marks the end of the range that you want to copy.
5. Release the COPY button.

The Modes

Understanding the different modes and their effect on the ER-101's behavior is very important for a smooth workflow experience. To understand the difference between the EDIT and FOLLOW modes, you just have to remember that every track has two cursors, a play cursor and an edit cursor, which are independent of each other. The CV outputs always reflect the step indicated by the play cursor and never the edit cursor. The primary purpose of the edit cursor is to allow you to edit a sequence while it is playing. The HOLD mode is the most complicated and will be described last.

Edit Mode

All of the other sections in this manual, assume by default that the ER-101 is in the EDIT mode. In this mode, the display always shows the edit cursor. The edit cursor will only move if the user moves it using the LEFT knob. Changes made to tracks while in EDIT mode are reflected immediately and can be heard the next time the play cursor encounters whatever it was that you changed.

Follow Mode

In FOLLOW mode, the display always shows the play cursor. The play cursor will move on its own to reflect the currently playing step and pattern. The user can also "scrub" the play cursor by focusing the PATTERN display or STEP display and turning the LEFT knob while in FOLLOW mode.

Certain operations are not allowed while in FOLLOW mode. If you attempt them, the VOLTAGE display will briefly flash *TILT* and your action is ignored. For example, INSERT, DELETE and changing step parameters such as CV-A, CV-B, DURATION and GATE are not allowed in FOLLOW mode unless the ER-101 is paused. However, setting loop points or enabling/disabling smoothing is allowed because doing these operations even on a moving target are still useful.

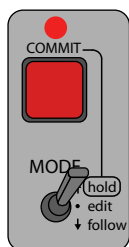

Hold Mode

This mode is extremely useful when you want to make many changes to a number of tracks and then have your changes reflected in the playing sequence all at once rather than as you make the edits. The easiest way to describe the HOLD mode is that it is exactly like the EDIT mode in that you are manipulating the edit cursor. However, you are editing a completely new copy of all the tracks. In other words, as soon as you enter the HOLD mode the entire contents of the ER-101 are copied (or shadowed) and all of your subsequent edits are made on this copy and therefore do not affect the material that is currently being played. This edited copy can be written onto the original at any time by pressing the COMMIT button. However, depending on the current focus this commit may be quantized in time or immediate.

Quantized Commit

If you press the COMMIT button while the focus is on TRACK, PATTERN, or STEP then your pending changes will be committed when the current track, pattern, or step ends, respectively. You can tell that a COMMIT is about to happen because the COMMIT LED will be flashing. You can select any of the four tracks to be used for timing this quantized commit by just focusing the desired track. This quantized commit mechanism allows you to introduce a whole batch of changes in time with currently playing material. You can even load an entire new snapshot and seamlessly cue it using the COMMIT button, all in time with your material.

Immediate Commit

If you press the COMMIT button twice, or if you press the COMMIT button while INDEX or SNAPSHOT are focused, then your changes will be committed immediately. You can throw away any changes without committing them by simply leaving the HOLD mode without pressing the COMMIT button.

Snapshots

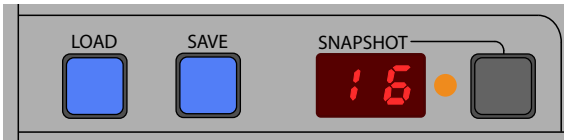

All state information contained in the four tracks can be saved as a snapshot at any time and loaded back later. Up to 16 snapshots can be saved in the ER-101's non-volatile flash memory.

To save the current state to a snapshot:

1. Press the SNAPSHOT button.
2. Use the LEFT knob to dial in the desired snapshot.
3. Press the SAVE button.
4. The word '*Abrt*' will flash to warn that you are about to overwrite the destination snapshot.
5. Press the SAVE button again to confirm, or press any other button to cancel.

If the desired destination snapshot is already showing, then just pressing the SAVE button (twice to confirm) is enough.

To load a snapshot:

1. Press the SNAPSHOT button.
2. Use the LEFT knob to dial in the desired snapshot.
3. Press the LOAD button.
4. The word '*Abrt*' will flash to warn that you are about to overwrite your current state.
5. Press the LOAD button again to confirm, or press any other button to cancel.

If the desired snapshot is already showing, then just pressing the LOAD button (twice to confirm) is enough. Loading a snapshot will reset all play and edit cursors to the beginning of their respective tracks, but the focused track will remain unchanged.

To load a blank snapshot (i.e. a fresh start):

1. Press the SNAPSHOT button.
2. Use the LEFT knob to dial in the blank snapshot denoted by '--'.
3. Press the LOAD button.
4. The word '*Abrt*' will flash to warn that you are about to clear your current state.
5. Press the LOAD button again to confirm, or press any other button to cancel.

The ER-101's flash memory is designed to hold your data safe for at least 100,000 writes with 15-year retention of data. On power-up, the ER-101 will load the last saved or loaded snapshot.

Moving snapshots between your computer and the ER-101

You can upload/download your snapshots to/from your computer by using the ER-101 Programmer software that is available for download from our website. The file format for snapshots is human-readable XML that is perfect for hacking, editing and creating your own snapshots on the computer and uploading them to the ER-101 later.

Warning for live performance situations! Saving a snapshot will cause the ER-101 to be unresponsive for about 0.75 seconds. Therefore, it is not recommended to save a snapshot while the sequencer is playing because it will ignore all CLOCK and RESET signals during this time. However, loading a snapshot is very fast (less than 1ms) and probably not a problem even in a live setting.

Track Options

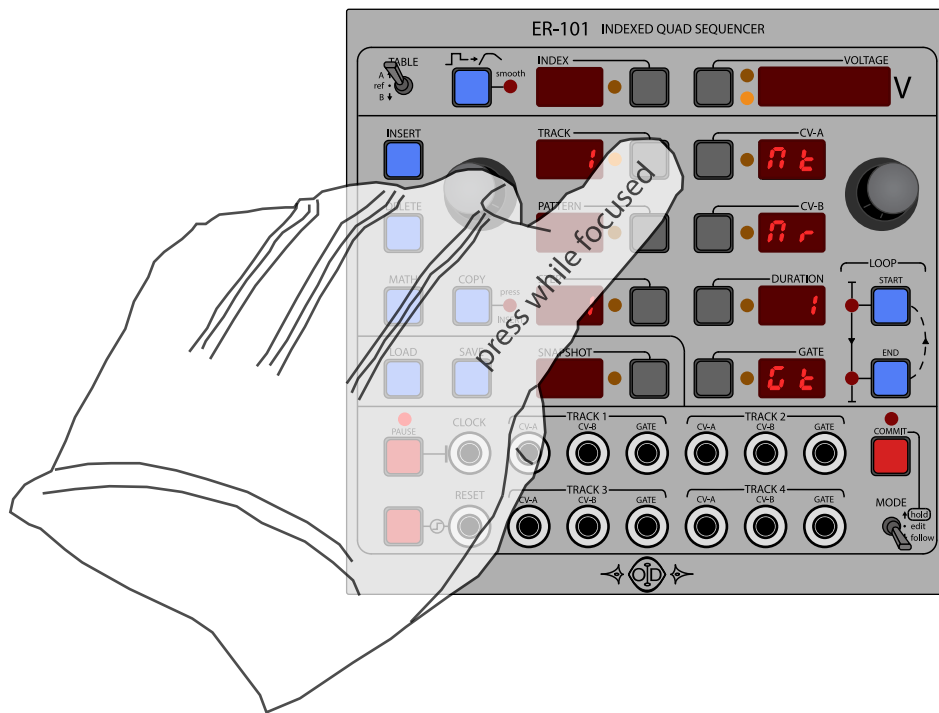

Each track has options that can be configured by pressing the TRACK button again once the TRACK display is focused (i.e. a focused press). Leave the track configuration screen by focus pressing the TRACK display again.

The track configuration screen shows 5 configurable options:

<u>Display</u>	<u>Option</u>	<u>Range</u>
CV-A	Note vs Number display for CV-A	Nt, Nr
CV-B	Note vs Number display for CV-B	Nt, Nr
DURATION	Clock Divider	1 to 99
STEP	Clock Multiplier	1 to 99
GATE	Gate vs Trigger	Gt, tr

While the TRACK configuration screen is displayed, focus a display and change its value using the RIGHT or LEFT knob. You can also press the focus button next to each display to have the non-numeric options cycle through their possible values.

Naturally, these track options are included when saving snapshots. These options settings are also included when copying and pasting tracks.

For more details on...

- the note vs numeric display please refer to the section called Voltage Tables.
- the clock divider/multiplier please refer to the section called Clock Division & Multiplication.
- gate mode vs trigger mode please refer to the section called Outputting Triggers.

Swinging and Shuffling

“Conserve duration by just moving the boundary between two steps.”

Sometimes, you will want to change the rhythm of a sequence without changing its total duration. To accomplish this, you must compensate any lengthening or shortening of a step with an equal amount of shortening or lengthening of another step or in other words you ‘swing’ the step. Using the editing functions described so far would require that you do this in two separate steps: navigate to one step, shorten/lengthen its DURATION, then navigate to another step and make an equal but opposite change to its DURATION. However, there is an easier way:

To transfer DURATION from one step to the next step:

1. Focus the STEP whose DURATION that you want to change.
2. Press and hold the DURATION button
3. Use the RIGHT knob to adjust the DURATION
4. While you do this, the next step’s DURATION will change in the exact opposite manner
5. Release the DURATION button

Another way of thinking of this operation is that you are moving the boundary between two steps back and forth. This is also very useful for making live changes to the rhythm of a sequence without losing synchronization with the other tracks or other material synchronized to the same clock.

In the example below, step 4 of pattern 1 has a DURATION of 16 pulses. The next step (e.g. step 5) also has a DURATION of 16 pulses. If we hold down the DURATION button and turn the RIGHT knob clockwise (i.e. increment) then we steal 1 pulse from the next step to the displayed step. The result is that the focused step has a DURATION of 17 pulses while the next step had its DURATION decreased to 15 pulses. The sum (32 pulses) stays the same throughout the operation.

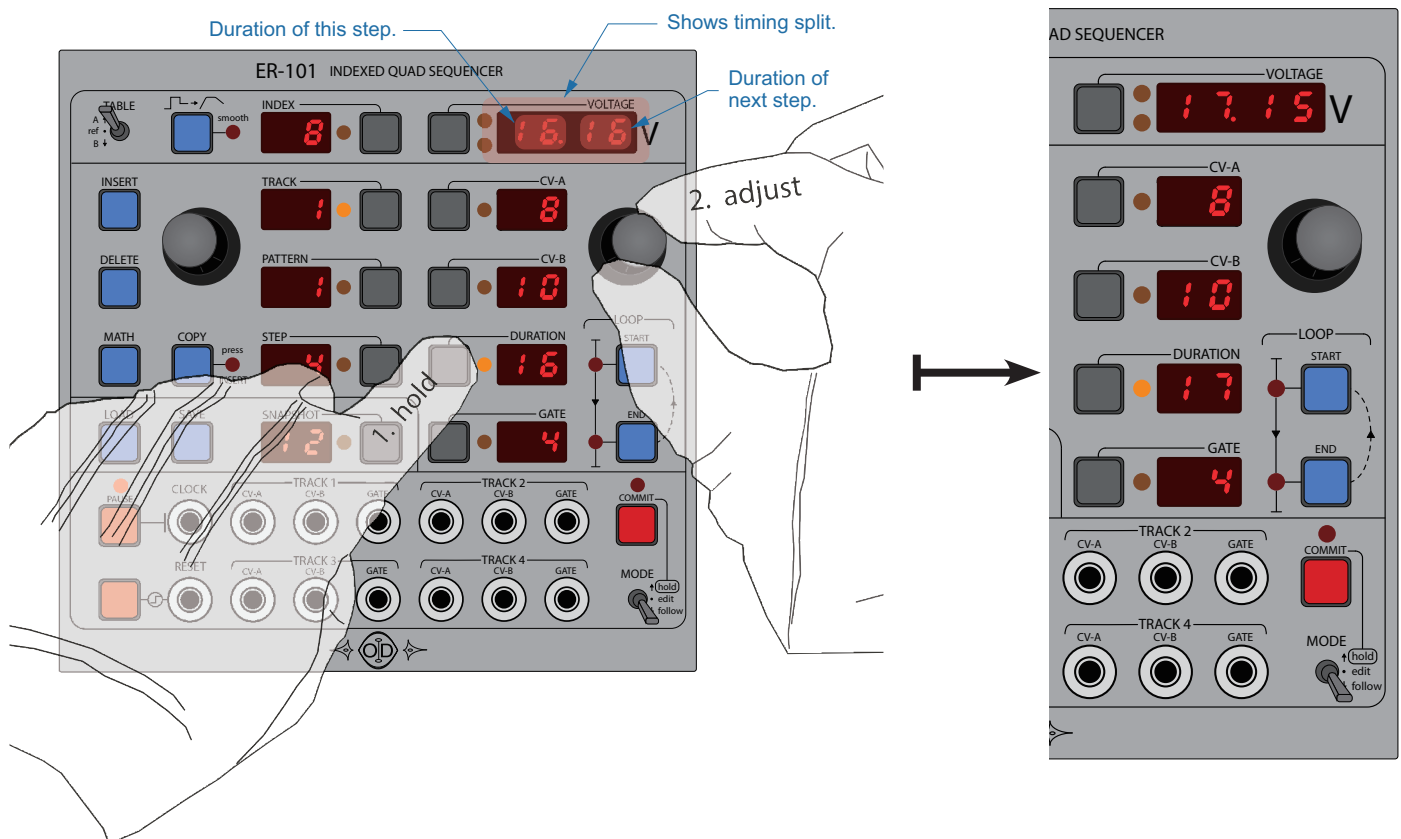

Voltage Tables

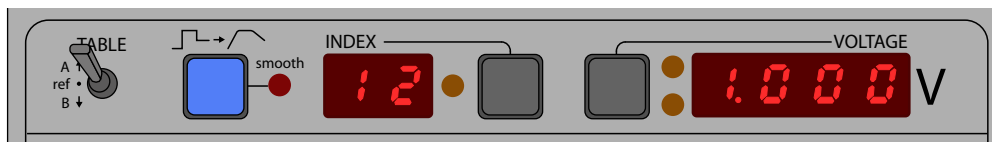

The ER-101 is an indexed sequencer because rather than having each step separately store its own voltage, each step just stores an index into a larger voltage table (two tables in fact, one for CV-A and one for CV-B). This is beneficial for the following reasons:

1. It would get very tedious to have to dial in a full resolution voltage for each step every time when using a rotary encoder with only 24ppr (pulses per revolution).
2. By indexing into a table of voltages, you can specify at the beginning what voltages are important for your current task. If you are using the output voltages to control pitch then you can think of the voltage tables as scales. Of course, the ER-101 will use all possible voltages when smoothly transitioning between two specific voltage levels.
3. Later you can alter the specific voltage levels independent of the CV-A and CV-B indices saved in your sequences. You want to flatten all of those B-flat's a little more? Just adjust the appropriate entry in the voltage table and all of the step's using that index will be affected.

Each voltage table contains 100 entries that are numbered (or indexed) from 0 to 99. Each of the 100 entries of a voltage table is assigned a voltage in the range 0.000V to 8.192V. In the picture above, you can see that index 12 has been assigned the voltage of 1.000V.

Each track has its own two voltage tables, one for CV-A and one for CV-B. This means that different sets of voltages can be used for each track and furthermore for CV-A and CV-B. Since these tables are editable, you can scan through each entry and alter the voltages as you wish. In addition to these track-specific tables, there are reference tables. These are tables that you can use to quickly initialize your track's voltage tables. There are two types of reference tables, built-in and user tables. You cannot alter the built-in reference tables but you can copy any table onto a user reference table or a track-specific table. The track voltage tables are unique in that you can edit each individual entry. Take a look at figure 4 below which portrays the different voltage tables and how they relate to each other.

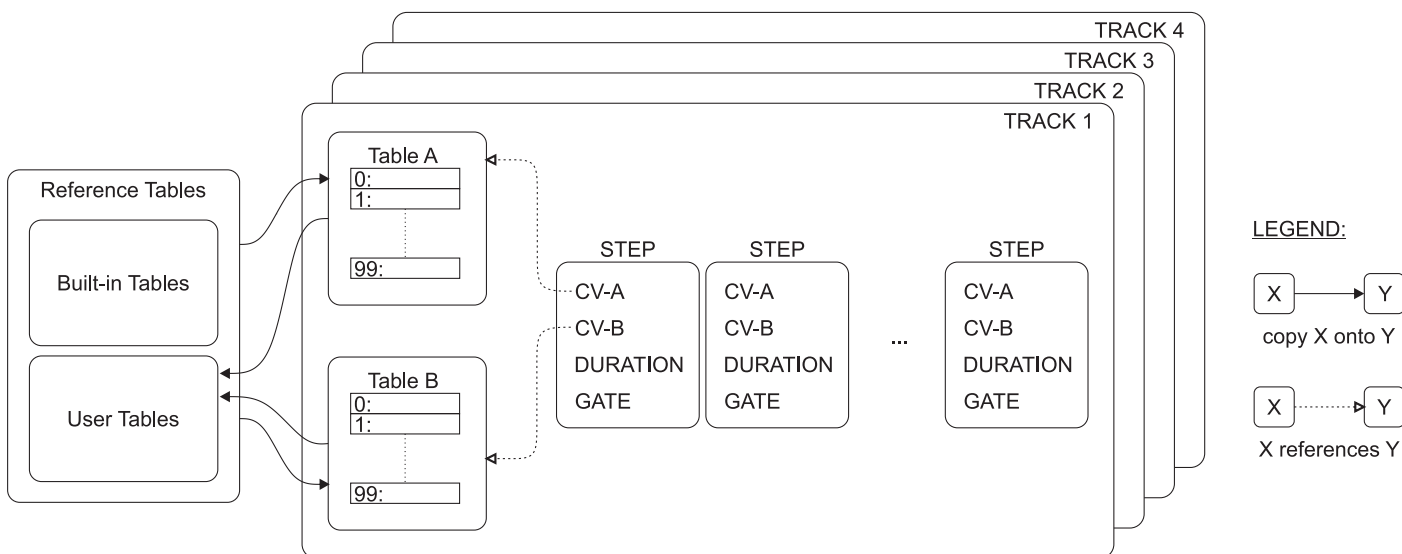

Figure 4: Voltage tables and their roles.

To browse the voltages in table A (or B):

1. Select the desired track.
2. Set the TABLE switch to A (or B).
3. Press the INDEX button.
4. Turn the LEFT knob to adjust the index of the voltage shown in the VOLTAGE display.

To edit the voltages in table A (or B):

1. Press the VOLTAGE button.
2. Turn the RIGHT knob to adjust the voltage in 2mV increments (fine mode).
3. Press the VOLTAGE button again.
4. Turn the RIGHT knob to adjust the voltage in 100mV increments (coarse mode).
5. Press the VOLTAGE button again.
6. Turn the RIGHT knob to adjust the voltage in 1V increments (super coarse mode).

Note Display vs Number Display

When note display is enabled (see Track Options) for a particular track and table (i.e. A or B) then the VOLTAGE display will show the voltage using a note from the chromatic scale otherwise it will just show the actual numeric value. The notes are displayed in the following format:

{octave: 0-8} . {note: A-G} . {% of a whole tone: 0-99}

The easiest way to understand this formatting is to just show a few examples:

<u>Typical Notation</u>	<u>ER-101 Notation</u>
C2	2.C.00
A#3	3.A.50
Bb5	5.A.50
G(half-#)4	4.G.25
G(#-and-a-half)4	4.G.75

Also, here is the first octave on the piano:

Lowest Octave	ER-101 Notation	Equivalent Voltage
C	0C.00	0.000V
C# / D \flat	0C.50	0.083V
D	0D.00	0.167V
D# / E \flat	0D.50	0.250V
E	0E.00	0.333V
F	0F.00	0.417V
F# / G \flat	0F.50	0.500V
G	0G.00	0.583V
G# / A \flat	0G.50	0.667V
A	0A.00	0.750V
A# / B \flat	0A.50	0.833V
B	0B.00	0.917V
	1C.00	1.000V
	.	.
	.	.
	.	.

Adjustment Granularity

When editing an entry of a voltage table you can choose whether to make fine adjustments, coarse adjustments or super coarse adjustments. You select the desired level of adjustment granularity by repeatedly pressing the VOLTAGE button, or, by holding the VOLTAGE button and turning the RIGHT knob. The available levels of adjustment granularity are:

<u>Level</u>	<u>Numeric Display</u>	<u>Note Display</u>
Fine	+/-2mV	+/-1% of whole tone
Coarse	+/-100mV	next/prev chromatic note
Super Coarse	+/-1V	+/-1 octave

The last used setting will be remembered and is included when saving snapshots.

Reference Tables

At any time if you move the TABLE switch to the REF position then you can access the reference tables. The reference tables are voltage tables that are meant to be used as starting points for building your own tables. The following reference voltage tables are currently provided:

<u>Name</u>	<u>Description</u>
12ET	12-tone equally tempered (i.e. semitones)
24ET	24-tone equally tempered (i.e. quartertones)
22JT	22-tone just intonation (in fact these are the 22 shrutis of India)
BLUE	diatonic scale plus flattened 3rd and 7th degrees
PEnt	0 to 49 is major pentatonic, 50 to 99 is minor pentatonic
L-8	rising linear ramp, 0 to 8.0V in increments of 100mV
E-8	rising exponential curve, 0 to 8.0V
LE-8	linear ramp, 0 to 0.1V (2mV increments) and exponential curve, 0.1 to 0.8V
USr1	user reference table #1
.	.
.	.
.	.
USr8	user reference table #8

To use a reference table just copy it to one of your track's voltage tables and then, if necessary, edit it to fit your needs.

To copy a reference table:

1. Set the TABLE switch to the REF position.
2. If it is not already focused, press the INDEX button.
3. Select the specific table with the RIGHT knob.
4. Press the COPY button and the INDEX LED will flash.
5. Now select table A or B with the TABLE switch.
6. Press the INSERT button to overwrite the destination table for the current track.
7. Repeat step 5 and 6 for as many tables as you desire.
8. Press the COPY button again to leave the copy mode.

To browse the voltages in a reference table:

1. Set the TABLE switch to the REF position.
2. Select the specific table with the RIGHT knob.
3. Use the LEFT knob to scroll through the index values.

The last eight reference tables in the list above are user reference tables that can be overwritten with your own customized tables. For example, suppose you have designed a unique scale or spent a lot of time customizing a voltage table for a non-1V/oct oscillator then you can copy your table onto one of the 8 user tables and thus have it easily available at all times. The procedure for saving one of your track's voltage tables onto a user reference table is the same as copying any voltage table. You focus the source table, press the COPY button and then focus the destination table, and press the INSERT button. Keep in mind that a voltage table is only focused if the INDEX display is focused.

To save a track's voltage table as a user reference table:

1. Focus the track containing the voltage table that you wish to save.
2. Set the TABLE switch to A or B depending on which table that you wish to save.
3. Press the focus button for the INDEX display and thereby select the voltage table.
4. Press the COPY button.
5. Now set the TABLE switch to the REF position.
6. Select the destination for your table with the RIGHT knob.
7. Press the INSERT button to save your table.
8. Repeat steps 6 and 7 as desired.
9. Press the COPY button again when you are done.

Loop Points

When a track reaches the LOOP END step, the sequence starts again from the LOOP START step. If there is no LOOP START step then the sequence starts playing again from the first step. If there is no LOOP END step then the sequence plays until the end before looping back to the LOOP START step.

To set the loop start (or end):

1. Navigate to the desired step.
2. Press the LOOP START (or END) button.

To clear the loop start (or end):

1. Navigate to the loop start step (the LOOP START or END indicator should light up).
2. Press the LOOP START (or END) button.

To clear the loop start (or end) without navigating to a loop point:

1. Press the LOOP START (or END) button twice.

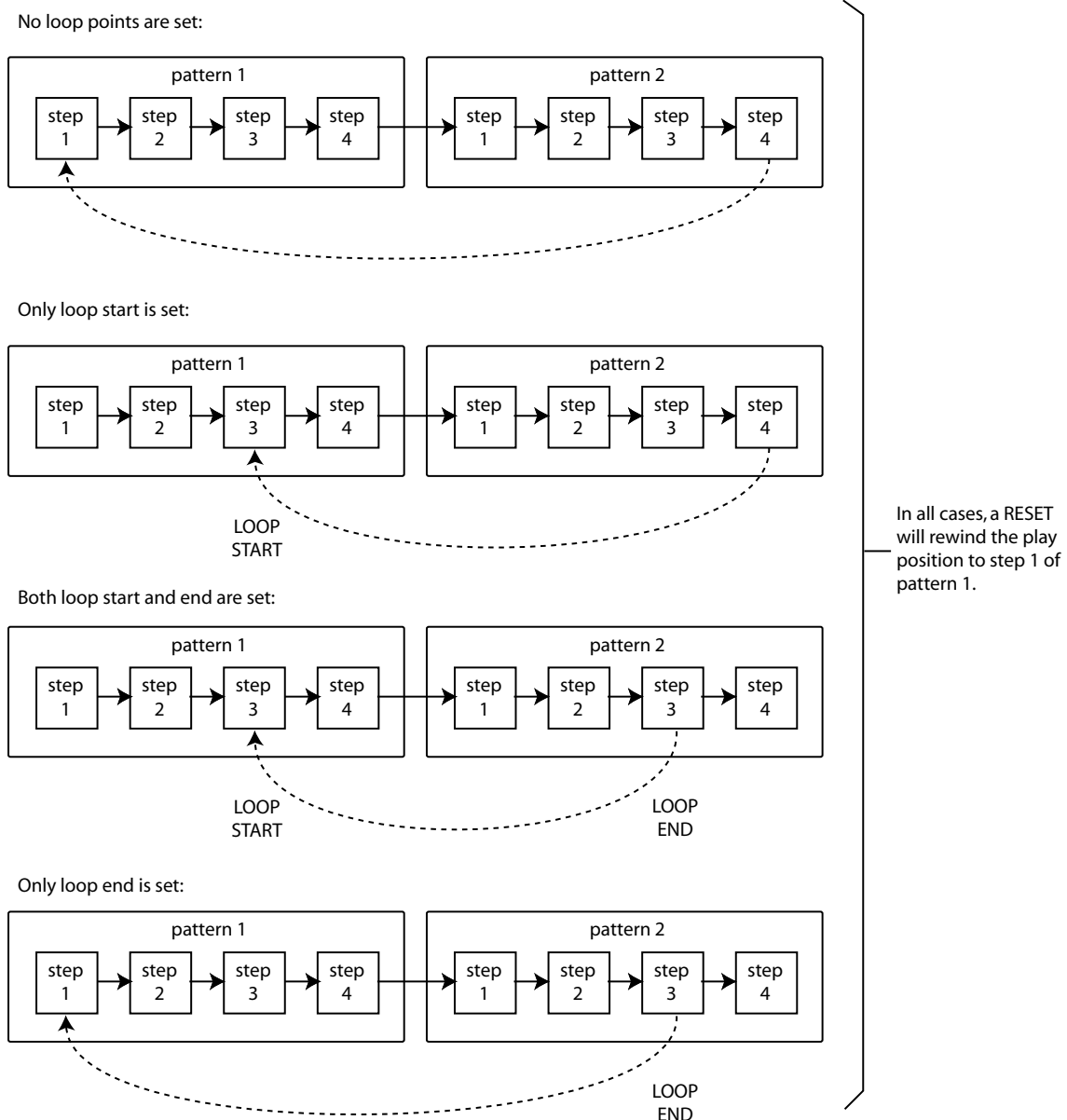

Figure 5

A special case: looping patterns

Looping any arbitrary subsequence of your track is as easy as navigating to the start step, pressing the LOOP START button and then navigating to the end sequence and pressing the LOOP END button (as described above). However, often we just want to loop a given pattern or sequence of patterns without having to navigate to the beginning or ending step of each pattern. In this case, the key to looping patterns is have the PATTERN display focused when pressing the LOOP START and END buttons:

To loop a single PATTERN:

1. If necessary, focus the PATTERN display.
2. Navigate to the desired PATTERN with the LEFT knob.
3. Press the LOOP START and END buttons.
4. Press the LOOP START and END buttons again to clear the loop.

In general, pressing the LOOP buttons while focused on a pattern will target the pattern's beginning or ending step depending on what makes sense. This allows for quick and convenient setting/clearing of loop points at the beginning and ending of any pattern.

The meaning of the LOOP LEDs also change slightly when the PATTERN display is focused. A constantly lit LOOP LED means that the entire focused pattern is looped whereas a flashing LOOP LED means that only part of the focused pattern is looped (supposedly because you set a LOOP point inside the pattern rather than on its first or last step). A sequence of patterns can be looped by just having the LOOP START and LOOP END fall on different PATTERNS.

To loop a sequence of PATTERNS:

1. If necessary, focus the PATTERN display.
2. Navigate to the first PATTERN in the loop with the LEFT knob.
3. Press the LOOP START button.
4. Navigate to the last PATTERN in the loop with the LEFT knob.
5. Press the LOOP END button.

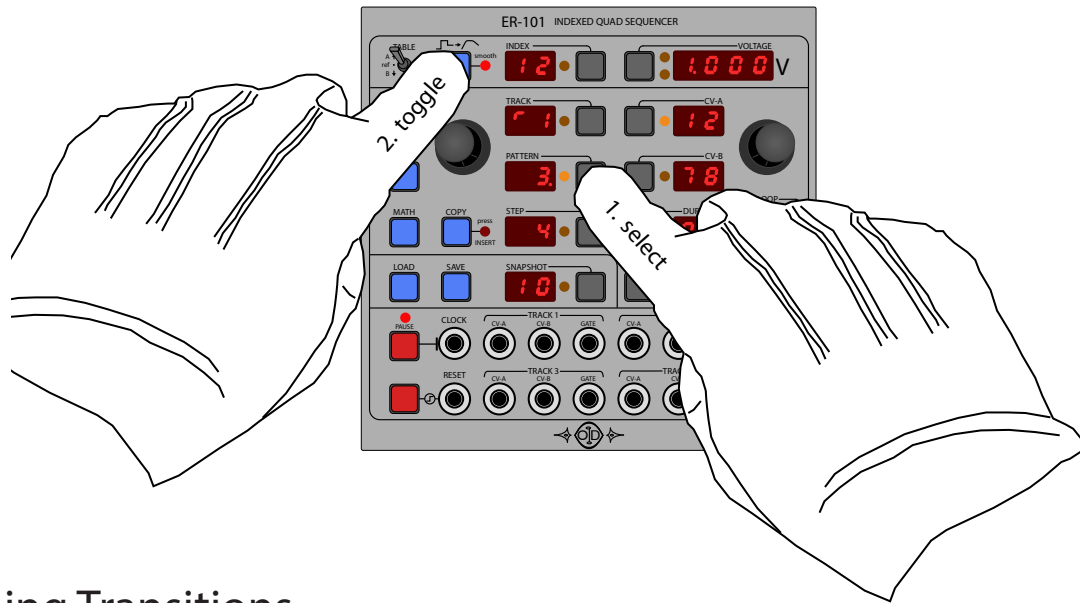

Smoothing Transitions

By default the transition from one CV to the next is stepped. However, with the SMOOTH button you can enable smoothing on individual steps, on individual patterns, for an entire track, or any combination of the three.

To toggle the smoothed transition from the end of the current step to the next step:

1. Set the TABLE switch to A or B, if necessary.
2. Press the STEP button to focus the current step.
3. Press the SMOOTH button.

To toggle smoothed transitions for all steps in the current pattern:

1. Set the TABLE switch to A or B, if necessary.
2. Press the PATTERN button to focus the current pattern.
3. Press the SMOOTH button.

To toggle smoothed transitions for all steps in the current track:

1. Set the TABLE switch to A or B, if necessary
2. Press the TRACK button to focus the current track.
3. Press the SMOOTH button.

Smoothing is enabled or disabled separately for the CV-A and CV-B outputs.

SMOOTH-A: CV-A voltage transition to the next step is linear (set) or abrupt (not set).

SMOOTH-B: CV-B voltage transition to the next step is linear (set) or abrupt (not set).

When toggling the smoothing behavior use the TABLE switch to focus the A or B outputs. The indicator light next to the SMOOTH button will light up if the current step is being smoothed because at least one of the following is true:

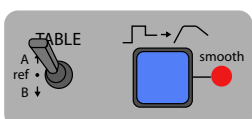

The smooth indicator is lit when...

- smoothing is enabled for the current track,
- or
- smoothing is enabled for the current pattern,
- or
- smoothing is enabled for the current step.

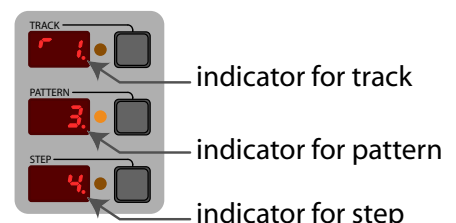

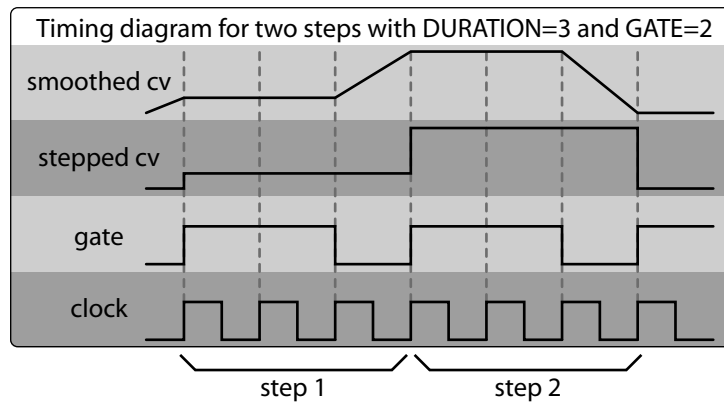

Figure 6: Effect of smoothing

Smoothing causes the voltage to linearly ramp from the current step's CV to the next step's CV. Figure 6 depicts this for a two step sequence. In the example sequence, both steps have the following parameters:

DURATION=3, GATE=2, SMOOTH-A=true, and SMOOTH-B= false.

The smoothed voltage transition starts when the gate goes low and proceeds until the next step. In other words, the length of a smoothed transition is DURATION minus GATE.

Ratcheting (aka note repeat)

Sometimes it is desirable for a given step to retrigger continuously such as when a drummer performs a fill, this is also called sequencer ratcheting. To toggle ratcheting on the current step simply press the GATE focus button while the GATE parameter is already focused. When ratcheting is enabled, you will see two dots light up at the bottom of the GATE display. Press the GATE button again to disable ratcheting.

Figure 7 shows what happens when ratcheting is enabled. In the first step, ratcheting is not enabled thus the gate fires only once at the beginning of the step and stays low for the remainder of the step's duration. In the second step, the gate fires repeatedly for the duration of the step. The gate length is always the same regardless. Therefore, the number of times the gate fires is implied by the length of the gate and the duration of the step. In the example in Figure 7, the step has a duration of 8 pulses and the gate has a length of 2 pulses (2 pulses for the high part, 2 pulses for the low part). Therefore, the gate fires twice:

HIGH for 2 pulses + LOW for 2 pulses + HIGH for 2 pulses + LOW for 2 pulses = 8 pulses.

If the gate length was 1 pulse then the gate would fire 4 times for a step with a duration of 8. This would also be the fastest ratchet possible at the current clock speed.

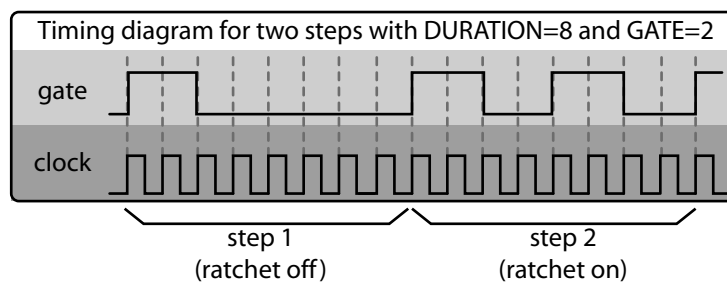



Figure 7: the ratcheting effect

Math Operations



The  button is a valuable tool for performing various operations on steps, patterns or entire tracks. The operations available in this version of the firmware are:

Arithmetic

Add or subtract a constant

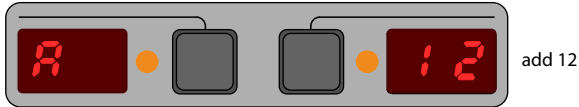

Geometric

Multiply or divide by a constant



Assignment

Set to a constant

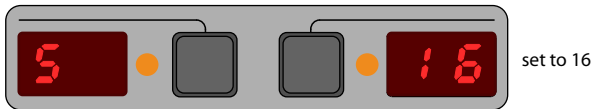

Random

Set to a random number between 0 and N



Jitter

Add a random number between -N and N



Quantize

Round to the nearest multiple of N



The code (A, G, S, rd, or Jt) on the left indicates the type of operation and the number on the right indicates the operand. Each step parameter has its own operation.

To apply the current math operation to the current step, pattern, or track:

1. Press the STEP or PATTERN or TRACK button.
2. Navigate to the desired step or pattern or track using the LEFT knob.
3. Press and release the MATH button.

To edit the current math operation:

1. Press and hold the MATH button. (The word PIN will flash in the VOLTAGE display.)
2. Press and release the VOLTAGE button to 'pin' the MATH's edit screen. Now you can release the MATH button.
3. Press one of the left focus buttons repeatedly, or turn the LEFT knob, to cycle through the available operations (A->G->S->rd->Jt->A...) for that parameter.
4. Edit the operands for CV-A, CV-B, DURATION and GATE by using the RIGHT knob.
5. At any time, you can press the MATH button to apply.
6. Press the VOLTAGE button to leave the math edit screen. (VOLTAGE display is flashing DONE to remind you of this.)

Note: For quick edits, you do not need to pin the edit screen. Just do your edits while holding the MATH button and then release to apply. If you change your mind about applying, then pin the edit screen and exit (i.e. press the VOLTAGE button twice, once to pin, once to exit).

To clear the math transform:

1. Press and hold the MATH button.
2. Press the DELETE button to reset the transform back to the identity transform.
3. Release the MATH button.

The idea is that you will prepare a math operation and then apply it multiple times to various parts of your sequence. The focus (i.e. a step or a pattern or an entire track) determines what steps are transformed. Each track has its own transform memory and these transforms are saved with the snapshots. For example, here is how to quickly create various rising sequences of control voltages.

1. First prepare the following MATH operation:

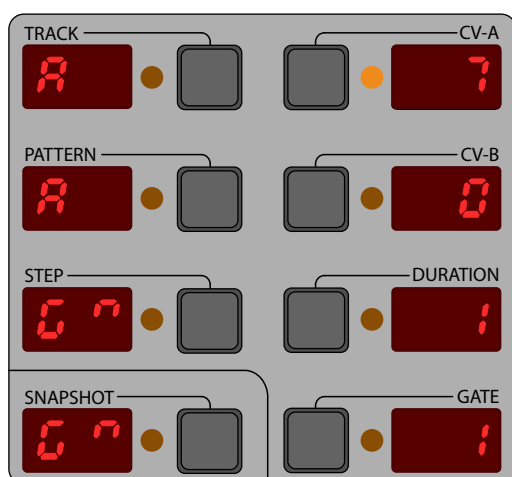

2. Press the PATTERN button.
3. Press the INSERT button to insert a new pattern.
4. Press the STEP button.
5. Press the INSERT button 4 times to insert 4 new steps.
6. Set CV-A for step 1 to 0, step 2 to 4, step 3 to 7 and step 4 to 4, and set the DURATION to 4 and the GATE to 2 for all steps. (You could use any desired values of course.)

7. Press the PATTERN button to focus the 4-step pattern that you just made.
8. Press the COPY button to copy the current pattern to the clipboard.
9. Press the INSERT button to paste the pattern after the current pattern.
10. Press the MATH button to add 7 to CV-A of all the steps in the pattern you just pasted.
11. Press the COPY button to clear the clipboard.
12. repeat (8)-(11) until you have the desired sequence length.

The result will be a sequence of patterns where each pattern is transposed upwards by 7 indices from the previous pattern. In fact, if table A was set to 12ET (which it is by default) then each pattern would be transposed up 7 semitones or a major 5th. And the sequence we just created is actually an arpeggiation of a major I chord successively transposed upwards by 5ths. Also, notice how the MATH operation left CV-B, DURATION and GATE unchanged because we had those parameter operations set to one of the null operations: Add zero, Multiply by one, Divide by one.

If you want to quickly clear the current MATH operation then just press the DELETE button at any time while editing the math operation.

Other uses for math operations are:

- Doubling or halving DURATION and/or GATE times.
- Silencing a pattern by setting the GATE value of all its steps to zero.
- Causing a pattern to be skipped by setting the DURATION value of all its steps to zero.
- Increasing or decreasing loudness in the case where CV-A or CV-B are controlling dynamics.
- Creating variations on a theme is easy when you combine the MATH and COPY operations.
- Use the jitter operation to humanize timing
- Use the jitter operation repeatedly with a small value to gradually evolve to randomness
- Use the random number operation to generate note durations or gate lengths for synthetic rain-type effect

Math operations are especially fun when applied in real-time to a playing sequence.

Out of bounds! If the operations above will cause a parameter to go out of bounds (i.e. 0 to 99) then the operation will leave the parameter unchanged. For example, trying to double the DURATION of a step from 64 to 128 will leave the DURATION at 64.

Outputting Triggers

A trigger is a very short digital pulse with a duration of just a few milliseconds. They are useful for pinging filters and some modules expect triggers rather than gates. On the ER-101 you can configure a track to output triggers instead of gates by simply changing the GATE mode in the track options screen:

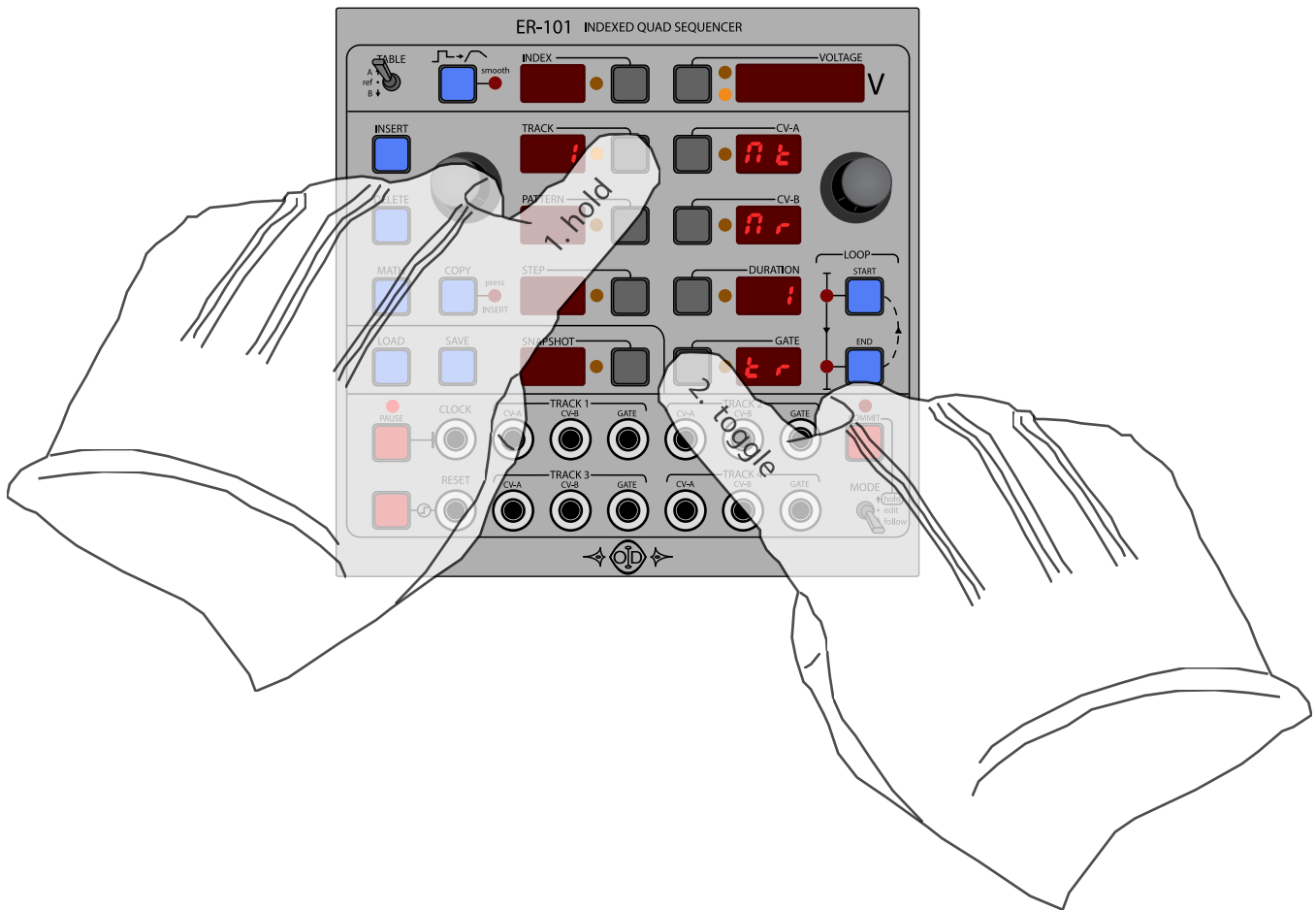

Once you have enabled triggers for a particular track then all gates for this track become triggers with durations equal to the step's GATE value multiplied by 0.1ms. So if a particular step has GATE=10 then the trigger will last $10 \times 0.1\text{ms} = 1\text{ms}$. Particularly when pinging a filter, different trigger lengths will sound different because a trigger's duration determines its frequency content. The range for triggers is 0.1ms to 9.9ms in 0.1ms increments.

Some other things that are affected by enabling trigger mode:

- If you enable note repeat (ratchet) while in trigger mode, then the trigger length defaults to 0.5ms and the GATE value now determines how many times the trigger will fire during the duration of the step. Notice, this is slightly different from the gate mode's note repeat.

Note: While in trigger mode, smoothing duration defaults to 50% of the step duration.

Clock Division & Multiplication

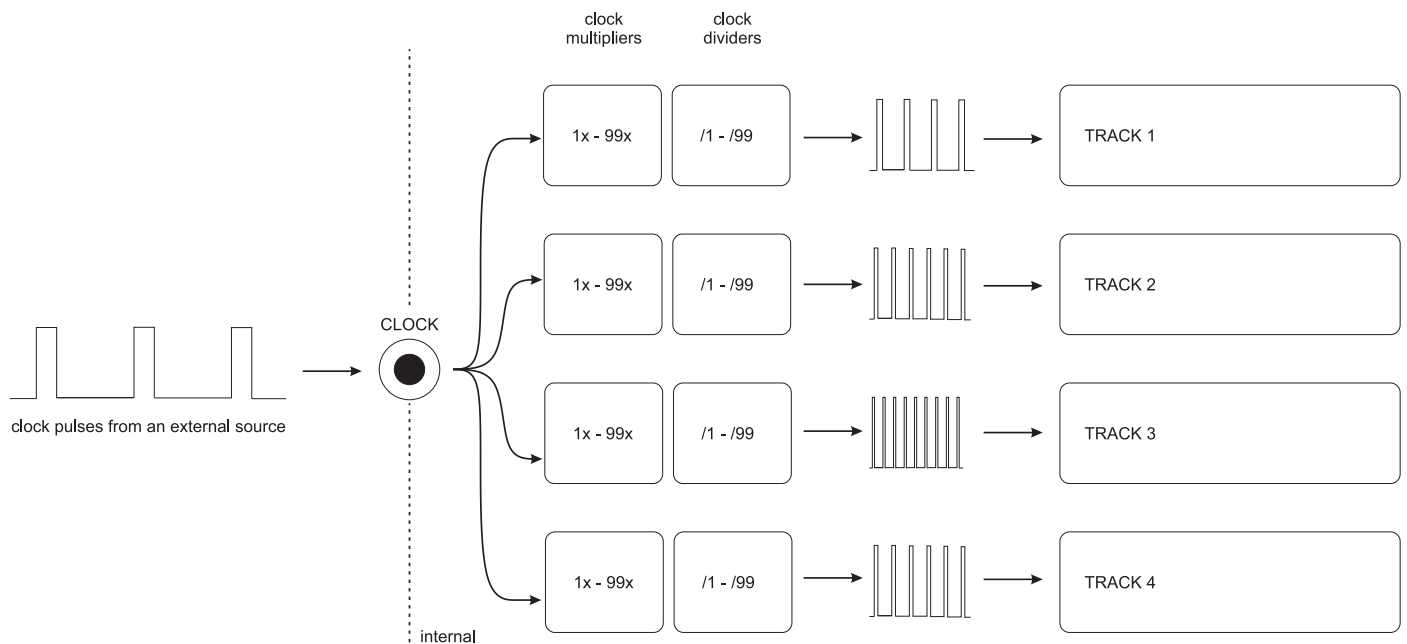

Each track can receive its own divided and multiplied version of the clock that is presented externally at the CLOCK input. The clock divider and multiplier that is used to derive the new clock for each track is adjusted in the track options screen. By default the clock dividers and multipliers are all set to one and thus pass the external clock unaffected.

Division

Clock division is achieved by counting the raw clock pulses and only passing a clock pulse when the counter reaches zero modulus the clock divider. For example, if the clock divider is 3 and we number the raw clock pulses as {1, 2, 3, 4, ...} then the divided clock will contain pulses {1, 4, 7, 10, ...}.

Multiplication

When the clock multiplier is set to a value greater than one, then the last seen period from the external clock is used to generate a faster clock. For example, suppose track 1's multiplier is set to 8 in the track options screen. The following will occur:

1. First the ER-101 waits until the next pulse on the external clock.
2. When this pulse arrives, output a pulse to track 1 and note the period. Let's call this period T.
3. Wait T/8 seconds.
4. Output another pulse to track 1.
5. Repeat step 3 and 4 until we have outputted 8 pulses including the pulse from step 2.
6. Go back to step 1.

(Throughout the above procedure, whenever an external pulse arrives, abort and start again from step 2.)

The above procedure generates 8 pulses for every single pulse from the external clock, thus running track 1 at 8 times the speed of the external clock. In other words, a step in track 1 with a DURATION=8 will last one cycle of the external clock. In addition, the above procedure guarantees two beneficial properties:

1. The synthesized clock is always in phase with the external clock.
2. The synthesized clock period tracks the external clock period but with a lag of one full period.

Caveat for synchronizing with various clock multipliers

If you change the clock multiplier or quickly change the external clock frequency while the sequencer is playing then a multiplied track will go out of sync with any other tracks with different clock multipliers. In these cases, just send the ER-101 a RESET to get all the tracks in sync again. This happens NOT because the multiplied clocks are out of phase with the external clock (they are guaranteed to be in sync) but rather because you changed the frequency of the clock in the middle of a step. This is typical (and probably unavoidable) behavior for patches that involve multiple clocks.

Tips & Tricks

Triangle LFO

This triangle wave is 32 pulses long and modulates from 0.0V to 8.0V.

STEP	CV*	DURATION	GATE	OTHER
1	0	16	0	SMOOTH=ON
2	96	16	0	SMOOTH=ON

* assumes 12ET voltage table.

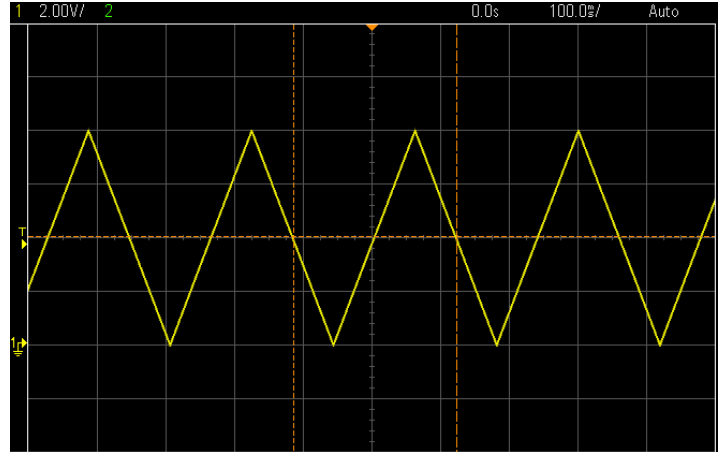

Sawtooth LFO

This falling sawtooth wave is 32 pulses long and modulates from 0.0V to 8.0V. Think of taking step 1 from the triangle example and making it shorter while making step 2 longer.

STEP	CV*	DURATION	GATE	OTHER
1	0	0	0	SMOOTH=ON
2	96	32	0	SMOOTH=ON

* assumes 12ET voltage table.

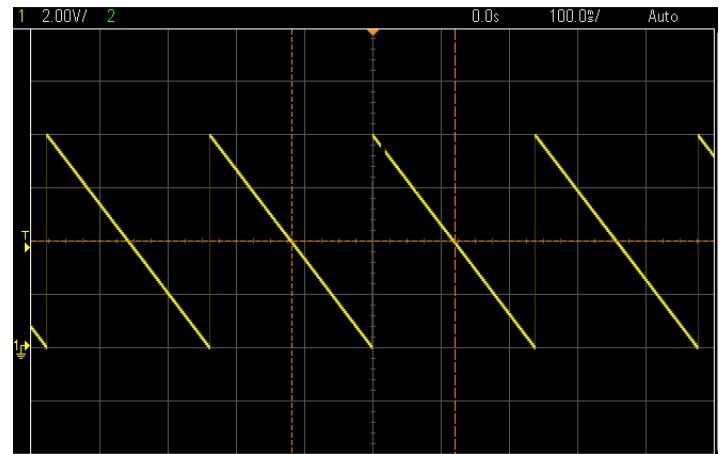

Sine LFO (piece-wise approximation)

Here is how you approximate a sine wave with 8 line segments, that starts at 4.0V, rises to 8.0V, falls to 0.0V and then rises to 4.0V to seamlessly repeat.

STEP	CV*	DURATION	GATE	OTHER
1	48	4	0	SMOOTH=ON
2	82	4	0	SMOOTH=ON
3	96	4	0	SMOOTH=ON
4	82	4	0	SMOOTH=ON
5	48	4	0	SMOOTH=ON
6	14	4	0	SMOOTH=ON
7	0	4	0	SMOOTH=ON
8	14	4	0	SMOOTH=ON

* assumes 12ET voltage table.

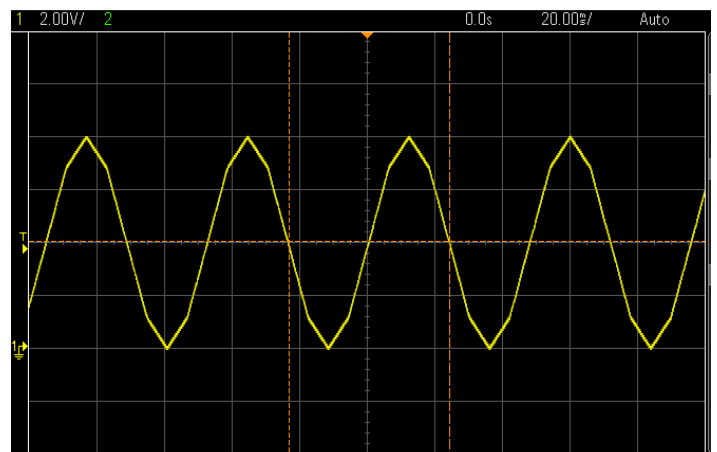

One-shot Sequences and Envelopes

To create a sequence that plays only once and then stops just end the sequence with a rest step (i.e. GATE=0) and then loop just this last step. To trigger the sequence press the RESET button or send a trigger into the RESET input.

Instant feedback for edits

There are two basic ways that you can hear your edits in real-time as you are making them.

Method 1: Edit while in FOLLOW mode and PAUSED but keep VCAs open.

FOLLOW mode means that any changes you make on the current step are immediately reflected in the CV outputs with the exception of the GATE outputs. You can scrub the play cursor while in FOLLOW mode even when UNPAUSED but you can only edit step parameters if the ER-101 is PAUSED. Also GATE outputs are disabled while PAUSED so you need to make sure any VCAs in the signal path are open in order to hear your changes. If you want to hear your real-time changes in all parameters (CV, DURATION, GATE, and SMOOTH), then I suggest method #2.

Method 2: UNPAUSE and edit in EDIT mode but LOOP the section that you are currently editing.

If you keep the LOOPed section short (e.g. one bar or phrase or even one step) then you can hear your changes as the ER-101 repeatedly loops around. You can even hear newly inserted steps if you make sure to insert the new steps in between the START and END loop points. When you are done editing that section then just move the LOOP points to the next section and repeat the process. Remember: You can even LOOP a single step.

Very long notes

It is often the case that you want to use a fast clock so that you have a finer grid for your rhythms. Unfortunately since the maximum DURATION for a step is 99 pulses, this also means that your longest step might not be long enough. The solution is easy: just “tie” a bunch of steps together by setting GATE=DURATION.

Velocity curves

Suppose you are using one of the CV outputs to control velocity (or loudness) but you decide you want a different feel. On a synthesizer keyboard this would be achieved by changing the velocity curve. You can get the same effect by changing the voltage table. You can try some of the reference tables, especially E-8 and LE-8, or you can roll your own.

Global control with voltage tables

Your voltage tables don't have to be monotonically-increasing. There is nothing stopping you from assigning CV index 80 to output 0V and CV index 10 to output 5V. Why would this be useful? Well suppose you are using CV to control accent in a drum beat. You could assign CV indices in the following manner: 1,2,3,4,1,2,3,4,1,2,3,4,... or any pattern that uses a small(ish) number of indices repeatedly. Now by adjusting the assigned voltage for say CV index 3, you can globally change the accent for all steps that have been assigned the CV index 3! You could set the output voltage for CV index 2 to 0V and turn all those notes off with one turn of the knob. The possibilities are endless.

Common Pitfalls

The current step is not advancing.

- Is the ER-101 paused? If the PAUSE LED is lit then the ER-101 is paused and you need to press the PAUSE button to unpause.
- Do you have more than one step in your sequence? If not then the ER-101 will just loop on this one step.
- Are both LOOP START and LOOP END lit? If so then you have told the ER-101 to loop over the current step only. Disable or move the loop points to include more of your sequence.
- Do you have a valid clock signal patched into the CLOCK input? The trigger threshold is around 2.5V. You should see the clock indicator rotating in the TRACK display.
- Are all step DURATIONS zero? At least one step must have a non-zero duration.
- Do you have a constant high voltage patched into the RESET input? This will keep the sequencer latched to the first step and ignore the CLOCK input until the RESET goes low again.

The gate output is always low (or high) and doesn't change.

- First make sure the current step is advancing. See above.
- Are all GATE parameters set to zero? $GATE=0$ means that the gate will stay low for the entire step (i.e. rest).
- Are all GATE parameters longer than the step DURATION? $GATE \geq DURATION$ means that the gate will stay high for the entire step (i.e. legato).

My edits are not having any effect.

- Are you in HOLD mode and have not pressed the COMMIT button? What catches some people off guard (including myself) is inadvertently having the ER-101 in HOLD mode and then wondering why none of your manipulations are being reflected in the output. When in HOLD mode, you are editing a shadow copy of everything which gets written onto your live material when you press the COMMIT button.
- Are you in FOLLOW mode? Most edits are not allowed in FOLLOW mode. Whenever you try to make an illegal edit while in this mode, the VOLTAGE display will flash the message: TILT.

Technical Matters

Analog Outputs

The two control voltage outputs (CV-A and CV-B) have a resolution of 14-bits and a range of 0-8.192V. In other words, you can specify voltages with a precision of 1mV and an accuracy of $\pm 1\text{mV}$.

Digital Outputs

The GATE outputs are 0V when low and at least 9.0V when high. When in trigger mode, the GATE outputs yield short pulses of a duration from 0.1ms to 9.9ms depending on the current step's GATE parameter.

Digital Inputs

A low-level logic reading on the CLOCK or RESET input is guaranteed for any voltage less than 1.5V and a high-level logic reading is guaranteed for any voltage greater than 3.5V. In practice, this means the threshold for a valid trigger on the CLOCK or RESET inputs is around 2.5V.

Update Rate

All outputs are updated at a rate of approximately 3kHz, or in other words, with a maximum 0.35ms latency.

Specifications

Width:	26hp
Depth:	2cm from the back of the faceplate
Current Consumption:	max 120mA from +12V (when +5V supply switch is in the REG position)
Total # of Tracks:	4
Total # of Patterns:	400 per snapshot or 100 per track
Total # of Steps:	2000 per snapshot, first-come-first-serve
Total # of Snapshots:	16

Firmware Updates

The ER-101 firmware can be easily and safely updated via the USB plug on the back of your module. The actual upload is performed using a desktop application called the **ER-101 Programmer** (available for Windows and Mac). For more information please refer to the following web page:

<http://www.orthogonaldevices.com/er-101/Programmer>

That's all for now. Enjoy!